



Pro2030



USER MANUAL

English

CONTENTS

Warranty	i
Introduction	1
Getting Started	1
Initial Inspection.....	1
Battery Installation	1
Key Pad	2
Connecting the Sensor and Cable	3
Membrane Installation	5
Run Screen.....	6
Backlight	7
Powering Off	7
Navigation.....	7
First Power On	8
System Setup Menu.....	8
DO Local%	9
Last Digit Suppression (LDS)	10
Quick DO Calibration (Quick DO Cal)	10
Audio	11
Contrast	11
Sensor Type	11
Membrane Type	12
Auto Stable.....	13
DO Units.....	14
Conductivity Units (Cond. Units).....	14
Specific Conductance Reference Temperature (SPC Ref. Temp.)	15
Specific Conductance Temperature Coefficient (SPC %/°C).....	16
TDS Constant.....	16
Temperature Units	17
Pressure Units.....	17

Item #605056
Rev C
Drawing # A605056
November 2010

©2010 YSI Incorporated.

The YSI logo is a registered trademarks of YSI Incorporated.
Teflon is a registered trademark of E. I. du Pont de Nemours and Company.

Language	17
Auto Shutoff	17
Resetting the System Setup Menu to Factory Default.....	18
Calibration	19
Temperature.....	19
Barometer	19
Dissolved Oxygen	19
Conductivity Calibration	22
Taking Measurements.....	25
Saving and Viewing Data	25
Saving Data.....	25
Viewing and Erasing Saved Data - Data Mode.....	26
Care, Maintenance and Storage	29
General Maintenance	29
Sensor Maintenance.....	30
Sensor Storage	35
Troubleshooting	36
Specifications.....	39
Accessories / Part Numbers	40
Declaration of Conformity.....	41
Recycling.....	42
Battery Disposal	42
Contact Information.....	43
Ordering and Technical Support.....	43
Service Information	43
Appendix A-DO% Calibration Values	44
Appendix B-Oxygen Solubility Table	45

WARRANTY

The YSI Professional 2030 instrument (Pro2030) is warranted for three (3) years from date of purchase by the end user against defects in materials and workmanship, exclusive of batteries and any damage caused by defective batteries. Pro2030 cable assemblies are warranted for two (2) years from date of purchase by the end user against defects in material and workmanship. Pro2030 Polarographic sensors are warranted for one (1) year and Galvanic sensors are warranted for six (6) months from date of purchase by the end user against defects in material and workmanship. Pro2030 instruments, cables & sensors are warranted for 90 days from date of purchase by the end user against defects in material and workmanship when purchased by rental agencies for rental purposes. Within the warranty period, YSI will repair or replace, at its sole discretion, free of charge, any product that YSI determines to be covered by this warranty.

To exercise this warranty, call your local YSI representative, or contact YSI Customer Service in Yellow Springs, Ohio at +1 937 767-7241, 800-897-4151 or visit www.YSI.com for a Product Return Form. Send the product and proof of purchase, transportation prepaid, to the Authorized Service Center selected by YSI. Repair or replacement will be made and the product returned, transportation prepaid. Repaired or replaced products are warranted for the balance of the original warranty period, or at least 90 days from date of repair or replacement.

LIMITATION OF WARRANTY

This Warranty does not apply to any YSI product damage or failure caused by:

1. Failure to install, operate or use the product in accordance with YSI's written instructions;
2. Abuse or misuse of the product;
3. Failure to maintain the product in accordance with YSI's written instructions or standard industry procedure;
4. Any improper repairs to the product;
5. Use by you of defective or improper components or parts in servicing or repairing the product;
6. Modification of the product in any way not expressly authorized by YSI.

THIS WARRANTY IS IN LIEU OF ALL OTHER WARRANTIES, EXPRESSED OR IMPLIED, INCLUDING ANY WARRANTY OF MERCHANTABILITY OR FITNESS FOR A PARTICULAR PURPOSE. YSI'S LIABILITY UNDER THIS WARRANTY IS LIMITED TO REPAIR OR REPLACEMENT OF THE PRODUCT, AND THIS SHALL BE YOUR SOLE AND EXCLUSIVE REMEDY FOR ANY DEFECTIVE PRODUCT COVERED BY THIS WARRANTY. IN NO EVENT SHALL YSI BE LIABLE FOR ANY SPECIAL, INDIRECT, INCIDENTAL OR CONSEQUENTIAL DAMAGES RESULTING FROM ANY DEFECTIVE PRODUCT COVERED BY THIS WARRANTY.

THIS PAGE LEFT INTENTIONALLY BLANK

INTRODUCTION

Thank you for purchasing the YSI Pro2030, an instrument from the YSI *Professional Series* product family. The Pro2030 measures dissolved oxygen, conductivity and temperature in water. The Pro2030 features an impact resistant and waterproof (IP-67) case, a rugged MS-8 (military-spec) cable connector, backlit display, user-selectable sensor options, 50 data set memory, internal barometer and a rubber over-mold case.

The Pro2030 provides valuable instructions and prompts near the bottom of the display that will guide you through operation and use. However, reading the entire manual is recommended for a better understanding of the instrument's features.



The Pro2030 cannot communicate to a PC via a Pro Series communications saddle. Connecting the Pro2030 to a communication saddle may cause erratic instrument behavior.

GETTING STARTED

INITIAL INSPECTION

Carefully unpack the instrument and accessories and inspect for damage. Compare received parts with items on the packing list. If any parts or materials are damaged or missing, contact YSI Customer Service at 800-897-4151 (+1 937 767-7241) or the authorized YSI distributor from whom the instrument was purchased.

BATTERY INSTALLATION

The instrument requires 2 alkaline C-cell batteries. Under normal conditions, the average battery life is 425 hours at room temperature without using the back light. A battery symbol  will blink in the lower, left corner of the display to indicate low batteries when approximately 1 hour of battery life remains.

To install or replace the batteries:

1. Turn the instrument off and flip over to view the battery cover on the back.
2. Unscrew the four captive battery cover screws.
3. Remove the battery cover and remove the old batteries if necessary.
4. Install the new batteries, ensuring correct polarity alignment (figure 1).

- Place the battery cover on the back of the instrument and tighten the four screws. Do not over-tighten.

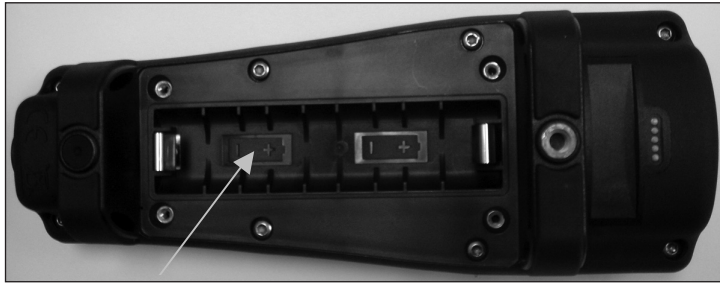

Figure 1. Pro2030 with battery cover removed. Notice battery symbols indicating polarities.

i The waterproof instrument case is sealed at the factory and is not to be opened, except by authorized service technicians. Do not attempt to separate the two halves of the instrument case as this may damage the instrument, break the waterproof seal, and will void the warranty.

KEY PAD

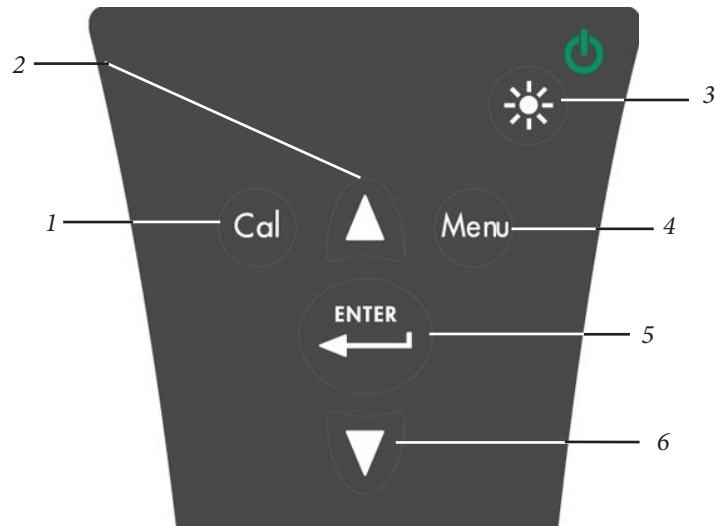

Figure 2, Keypad

Number	Key	Description
1		Calibrate Press and hold for 3 seconds to calibrate. Opens Calibrate menu from the Run screen.
2		Up Arrow Use to navigate through menus, to navigate through box options along the bottom of the Run screen and to increase numerical inputs.
3		Power and Backlight Press once to turn instrument on. Press a second time to turn backlight on. Press a third time to turn backlight off. Press and hold for 3 seconds to turn instrument off.
4		Menu Use to enter the System Setup menu from the Run screen.
5		Enter Press to confirm entries and selections.
6		Down Arrow Use to navigate through menus, to navigate through box options at the bottom of the Run screen and to decrease numerical inputs.

CONNECTING THE SENSOR AND CABLE

“Bulkhead” refers to the single-pin connector at the end of the probe/cable assembly where the dissolved oxygen (DO) sensor is installed (figure 3). The conductivity and temperature sensors are located above and next to the bulkhead respectively and are not user-replaceable.

i When a dissolved oxygen sensor is not installed in the cable, the sensor and cable's bulkhead connectors are not water-proof. Do not submerge the cable without a sensor installed. Submerging the cable without a sensor installed may cause permanent damage to the cable that is not covered under warranty.

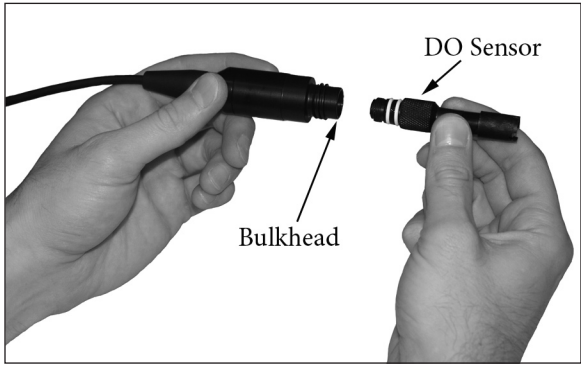

Figure 3

INSTALLING THE DISSOLVED OXYGEN SENSOR

The Pro2030 has two compatible dissolved oxygen sensors:

Polarographic – This sensor has a black sensor body and is engraved with the model number 2003. Polarographic will be abbreviated Polaro in the instrument's menu.

Galvanic – This sensor has a grey sensor body and is engraved with the model number 2002.

For information on the differences between these two types of sensors, see Sensor Type in the System Setup Menu section of this manual.



Before installing either sensor or connecting the cable to the instrument, the Sensor Type must be configured for the sensor being installed/connected. Failure to do this may result in damage not covered under warranty. The instrument will step you through this setup the first time the instrument is powered on. See the System Setup Menu section of this manual for instructions on configuring the Sensor Type after the first power on.

1. Remove the red plastic plug from the cable's bulkhead port by pulling it straight out of the port. This can be discarded.
2. Remove the red plastic plug from the sensor's connector by pulling it straight off the sensor. This can be discarded.
3. Ensure both the sensor connector and bulkhead connector on the cable are clean and dry.
4. Grasp the sensor with one hand and the cable bulkhead in the other.

5. Push the sensor into the connector on the cable until it is firmly seated and only 1 o-ring is visible. Failure to properly seat the sensor may result in damage.
6. Twist the sensor clockwise to engage the threads and finger tighten. Do NOT use a tool. This connection is water-tight.

For more detailed instructions, please refer to the sensor installation sheet that is included with each sensor.

CONNECTING THE PROBE/CABLE ASSEMBLY TO THE INSTRUMENT

To connect the cable, align the keys on the cable connector to the slots on the instrument connector. Push together firmly and then twist the outer ring until it locks into place (figure 4). This connection is water-proof.



Figure 4, Note the keyed connector.

MEMBRANE INSTALLATION

The sensing end of the dissolved oxygen sensor is shipped with a protective red cap that needs to be removed before using. Additionally, it is very important to install a new membrane with electrolyte solution onto the sensor after removing the red cap.

Prepare the electrolyte solution according to the instructions on the bottle. After mixing, allow the solution to sit for 1 hour. This will help prevent air bubbles from later developing under the membrane. Ensure you are using the correct electrolyte solution for your sensor. Galvanic sensors utilize electrolyte with a

light blue label on the bottle and Polarographic sensors utilize electrolyte with a white label on the bottle. The dissolved oxygen sensor is supplied with cap membranes specific to the sensor type ordered (Polarographic or Galvanic). 5913 and 5914 membrane kits are for Galvanic sensors and the 5908 and 5909 membrane kits are for Polarographic sensors.

Remove and discard or save the red protective cap from the dissolved oxygen sensor by pulling it straight off. Thoroughly rinse the sensor tip with distilled or deionized water. Fill the cap membrane 3/4 full of electrolyte solution, then tap the cap with a finger to release any trapped air. Be careful not to touch the membrane portion of the cap. Thread the membrane cap onto the sensor, moderately tight. Do not use a tool. It's typical for some of the electrolyte solution to spill over. It is best to allow the new cap to remain on the sensor overnight before calibrating. For detailed instructions on changing a cap membrane, see the Care, Maintenance and Storage section of this manual.

RUN SCREEN

Press the power/backlight key  to turn the instrument on. The instrument will run through a self test and briefly display a splash screen with system information before displaying the main Run screen (figure 5). The first time the Pro2030 is turned on, it will step through language, sensor and membrane selections; see the First Power On section of this manual for more information.

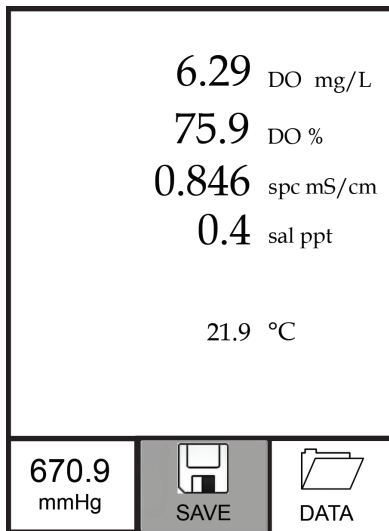



Figure 5, Run screen.

BACKLIGHT

Once the instrument is powered on, pressing the power/backlight key  will turn on the display backlight. The backlight will remain on until the key is pressed again or after two minutes of not pressing any key on the keypad.



POWERING OFF

To turn the instrument off, press and hold the power/backlight key  for three seconds.



NAVIGATION

The up  and down  arrow keys allow you to navigate through the functions of the Pro2030.

NAVIGATING THE RUN SCREEN

When in the Run screen, the up  and down  arrow keys will move the highlighted box along the bottom options. Once a box is highlighted, press enter to access the highlighted option.

Description of Run screen box functions from left to right:

Option	Description
Barometer reading	Highlight and press enter to calibrate the barometer.
 SAVE	Highlight and press enter to save displayed data to memory.
 DATA	Highlight and press enter to view and/or erase saved data.

NAVIGATING THE SYSTEM SETUP MENU

When in the System Setup menu, the up and down arrow keys will move the highlighted bar up and down the system setup options. See the System Setup menu section of this manual for more information about these options.

FIRST POWER ON

The instrument will step through an initial configuration when powered on for the first time. This will set the language, dissolved oxygen sensor type and membrane type. Use the up or down arrow keys to highlight the appropriate language, sensor and membrane, then press enter to confirm (figures 6). The Sensor Type must be configured for the dissolved oxygen sensor installed on the cable. Failure to do this may result in damage not covered under warranty. If an incorrect option is selected, it may be changed in the System Setup menu.

<p>Select Language:</p> <p><input checked="" type="checkbox"/> English <input type="checkbox"/> Français <input type="checkbox"/> Español <input type="checkbox"/> Deutsch</p> <p>Use ▲▼ to select Language Press ↵ to confirm</p>	<p>Select Sensor Type:</p> <p><input checked="" type="checkbox"/> Polaro (black) <input type="checkbox"/> Galvanic (grey)</p> <p>Use ▲▼ to select sensor type Press ↵ to confirm</p>	<p>Select Membrane Type:</p> <p><input checked="" type="checkbox"/> 1.25 (Yellow) <input type="checkbox"/> 2.0 (Blue)</p> <p>Use ▲▼ to select membrane Press ↵ to confirm</p>
--	--	---

Figure 6, Select language, dissolved oxygen sensor and membrane.

After selecting a language, sensor and membrane, the Run screen will be displayed. The next time the instrument is powered up, the Run screen will display immediately after the splash screen. If the sensor type or membrane type is changed, ensure that it is updated in the System Setup menu.

SYSTEM SETUP MENU

Press the menu  key to access the System Setup menu. The System Setup menu contains multiple screens that are notated as 'pages'. The current page is indicated near the bottom of the display (figure 7).

Use the up and down arrow keys to scroll through menu options and menu pages.

EXITING THE SYSTEM SETUP MENU

To exit the System Setup menu, press the down arrow key until the ESC - Exit box is highlighted, then press enter to return to the Run screen.

DO LOCAL%

DO Local% can be enabled or disabled by using the up or down arrow keys to highlight it and then pressing enter . An 'X' in the box next to DO Local% indicates it is enabled (Figure 7).

<p><input checked="" type="checkbox"/> DO Local%</p> <p><input type="checkbox"/> LDS</p> <p><input type="checkbox"/> Quick DO Cal</p> <p><input type="checkbox"/> Audio</p> <p>Contrast</p> <p>Sensor Type</p> <p>Membrane Type</p> <p>Page 1 of 3</p>	<p>ESC Exit</p>	<p> Reset</p>	
--	---------------------	--	--

Figure 7, page 1 of System Setup menu. DO Local% is enabled.

When DO Local% is enabled, DO% values will be expressed as %L on the Run screen.

DO Local% allows for localized % saturation measurements, but does not affect the mg/L readings. When enabled, the DO% calibration value is always 100% regardless of the altitude or barometric pressure of the location. This deviates from YSI's traditional method of expressing DO% saturation where the % calibration value decreases with a decrease in barometric pressure, i.e. an increase in altitude (Appendix A). To determine the % calibration value when DO Local% is disabled, divide the local barometric pressure pressure in mmHg by 760 and then multiply by 100.

Example: $750/760 = 0.9868 \times 100 = 98.68\%$ calibration value when DO Local is disabled.

When DO Local% is enabled, the Pro2030 corrects for barometric pressure on each DO measurement instead of during calibration.

Example:

Instrument #1 with DO Local% enabled:

At 737 mmHg barometric pressure, roughly 841 ft above sea level, the instrument would calibrate to 100%.

When taking measurements at the same location (737 mmHg) in a 20°C fresh water sample that is completely air-saturated, the instrument would read:

DO %L value = 100%

DO mg/L value = 8.81 mg/L ($9.09^1 \times .9697^2$)

Instrument #2 DO Local% disabled:

At 737 mmHg barometric pressure, roughly 841 ft above sea level, the instrument would calibrate to $737/760 \times 100\% = 96.97\%$

When taking measurements at the same location (737 mmHg) in a 20°C fresh water sample that is completely air-saturated, the instrument would read:

DO% value = 96.97%

DO mg/L value = 8.81 mg/L ($9.09^1 \times .9697^2$)

Hence, the mg/L readings are unaffected by DO Local%.

- 1.) Value from oxygen solubility table (Appendix B).
- 2.) $737/760 \times 100\%$, correction for barometric pressure.

LAST DIGIT SUPPRESSION (LDS)

Last Digit Suppression (LDS) can be enabled or disabled by using the up or down arrow keys to highlight it and pressing enter . An 'X' in the box next to LDS indicates it is enabled.

LDS rounds the DO value to the nearest tenth; i.e. 8.25 mg/L becomes 8.3 mg/L. LDS is automatically disabled during calibrations.

QUICK DO CALIBRATION (QUICK DO CAL)

Quick DO Cal can be enabled or disabled by using the up or down arrow keys to highlight Quick DO Cal and pressing enter. An 'X' in the box next to Quick DO Cal indicates it is enabled.

When Quick DO Cal is enabled, press and hold the calibration  key for 3 seconds while in the Run screen. Next, highlight Dissolved Oxygen and press enter to calibrate the DO sensor to the instrument's barometer reading. For more information on Quick DO Cal, see the Calibration section of this manual.

AUDIO

Audio can be enabled or disabled by using the up or down arrow keys to highlight Audio and pressing enter. When enabled, there will be an 'X' in the box next to Audio.

When Audio is enabled, the Pro2030 will beep twice to indicate stability when Auto Stable is enabled. The instrument will also beep when a key is pressed. When Audio is disabled, the Pro2030 will not beep.

CONTRAST

To adjust the display Contrast, use the up or down arrow keys to highlight Contrast, then press enter. Next, use the up or down arrow keys to adjust the contrast. The up arrow key will darken the contrast and the down arrow key will lighten the contrast. After adjusting the contrast, press enter to save and exit the Contrast adjustment option.

EMERGENCY CONTRAST ADJUSTMENT

If necessary, there is an alternate method of adjusting the contrast. To adjust the contrast, press and hold the menu key, then press the up arrow key to darken the contrast or press the down arrow key to lighten the contrast.

SENSOR TYPE

Sensor Type sets the type of dissolved oxygen sensor being used; either Polarographic (black) or Galvanic (grey).



The instrument's Sensor Type must be configured for the sensor installed. Failure to do this may result in damage not covered under warranty. If you observe readings very close to 0 or extremely high readings, i.e. 600%, the Sensor Type setting may be incorrect.

Use the up or down arrow keys to highlight Sensor Type, then press enter to open a submenu. Highlight the sensor type corresponding to the sensor installed on the cable and press enter to confirm. The enabled sensor type will have an 'X' in the box next to it. Next, use the down arrow key to highlight the ESC – Exit, then press enter to save changes and to close the sensor submenu.

The Pro2030 has two compatible sensors for use with a field cable:

Polarographic – This sensor has a black sensor body and is engraved with the model number 2003. Polarographic will be abbreviated Polaro in the instrument.

Galvanic – This sensor has a grey sensor body and is engraved with the model number 2002.

In terms of physical configuration, membrane material and general performance, YSI Professional Series Galvanic dissolved oxygen sensors are exactly like the Professional Series Polarographic sensors. The advantage of using Galvanic sensors is convenience. Galvanic sensors provide an instant-on sensor without the need for warm-up time but this affects the life of the sensor. Polarographic sensors last longer and have a longer warranty but require a 5-15 minute warm-up time before use or calibration.

MEMBRANE TYPE

Membrane Type sets the type of membrane used on the dissolved oxygen sensor; either 1.25 PE (Yellow) or 2.0 PE (blue). Use the up or down arrow keys to highlight Membrane Type and press enter to open the membrane submenu. Highlight the membrane type corresponding to the membrane installed on the sensor and press enter to confirm. The enabled membrane type will have an 'X' in the box next to it. Use the down arrow key to highlight the ESC – Exit box along the bottom of the display and press enter to save changes and to close the membrane submenu.

The dissolved oxygen sensor is supplied with membranes specific to the sensor type and are color coded as described in the following tables.

Galvanic Membrane Kits:

<i>Item</i>	<i>Color</i>	<i>Material</i>	<i>Description</i>
5913	Yellow	1.25 mil polyethylene (PE)	Faster response time and less flow dependence than traditional Teflon® membranes.
5914	Blue	2.0 mil polyethylene (PE)	Less flow dependence than 1.25 mil membrane but somewhat slower response.

Polarographic Membrane Kits:

<i>Item</i>	<i>Color</i>	<i>Material</i>	<i>Description</i>
5908	Yellow	1.25 mil polyethylene (PE)	Faster response time and less flow dependence than traditional Teflon® membranes.
5909	Blue	2.0 mil polyethylene (PE)	Less flow dependence than 1.25 mil membrane but somewhat slower response.

Selecting a Dissolved Oxygen Membrane:

<i>Membrane Type</i>	<i>Flow Dependence After 4 Minutes</i>	<i>Required Sample Movement</i>	<i>Typical Response Time (T-95)</i>
5913, 5908 Yellow	25%	6 inches/second	8 seconds
5914, 5909 Blue	18%	3 inches/second	17 seconds

AUTO STABLE

Auto Stable utilizes preset values to indicate when a reading is stable. The preset values are adjustable in the System Setup menu. The user can input a % change in readings (0.0 to 1.9) over 'x' amount of time in seconds (3-19). There are two separate Auto Stable controls, one for dissolved oxygen readings (DO Auto Stable) and one for conductivity readings (Cond. Auto Stable).

Highlight either DO Auto Stable or Cond. Auto Stable, then press enter to open the submenu.

Use the up or down arrow keys to highlight the % change or seconds (secs) input field, then press enter to make the highlighted field adjustable. Use the up or down arrow keys to adjust the selected value, then press enter to confirm changes. Once you have confirmed any changes, highlight the ESC-Exit box along the bottom of the display and press enter to close the Auto Stable submenu.

To disable Auto Stable, set the % Change input to 0.0.

When Auto Stable is enabled, an AS symbol will display next to the reading on the Run screen and blink during stabilization. When the dissolved oxygen and/or conductivity reading stabilizes based on the Auto Stable settings, the AS symbol will display steadily and the instrument will beep twice if Audio is turned on.

DO UNITS

Highlight DO Units and press enter to open a submenu that allows you to select the dissolved oxygen units to be displayed on the Run screen. Highlight a unit and press enter to enable or disable it. An enabled dissolved oxygen unit will have an 'X' in the box next to it. Highlight the ESC-Exit box along the bottom of the display and press enter to save any changes and to close the DO units submenu.

There are three options for displaying dissolved oxygen:

- mg/L will show DO readings in milligrams per liter on a scale from 0 to 50 mg/L.
- ppm (parts per million) is equivalent to mg/L and will show the DO reading on a scale from 0 to 50 ppm.
- % will show DO readings in a % saturation from 0 to 500%. This value will be expressed as %L when DO Local% is enabled.

mg/L and ppm cannot be enabled and therefore displayed at the same time. DO% and mg/L or ppm can be enabled and displayed simultaneously.

CONDUCTIVITY UNITS (COND. UNITS)

Highlight Cond. Units (Conductivity Units) and press enter to open a submenu that allows you to select the conductivity units to be displayed on the Run screen. Highlight a unit and press enter to enable or disable it. An enabled conductivity unit will have an 'X' in the box next to it. Highlight the ESC-Exit box along the bottom of the display and press enter to save any changes and to close the conductivity units submenu.

There are seven options for displaying conductivity. Only two units can be enabled at the same time:

- COND-mS/cm displays conductivity in milliSiemens per centimeter.
- COND-uS/cm displays conductivity in microSiemens per centimeter.
- SPC-mS/cm displays Specific Conductance in milliSiemens per centimeter. Specific Conductance is temperature compensated conductivity.
- SPC-uS/cm displays Specific Conductance in microSiemens per centimeter. Specific Conductance is temperature compensated conductivity.
- Sal ppt displays salinity in parts per thousand. The salinity reading is calculated from the instrument's conductivity and temperature values using algorithms found in *Standard Methods for the Examination of Water and Wastewater*.

- TDS g/L displays Total Dissolved Solids in grams per liter. TDS is calculated from conductivity and temperature using a user-selectable TDS constant.
- TDS mg/L displays Total Dissolved Solids in milligrams per liter. TDS is calculated from conductivity and temperature using a user-selectable TDS constant.

Note: 1 milliSiemen = 1,000 microSiemens.

SPECIFIC CONDUCTANCE

The conductivity of a sample is highly dependent on temperature, varying as much as 3% for each change of one degree Celsius (temperature coefficient = 3%/°C). In addition, the temperature coefficient itself varies with the nature of the ionic species present in the sample. Therefore, it is useful to compensate for this temperature dependence in order to quickly compare conductivity readings taken at different temperatures.

The Pro2030 can display non-temperature compensated conductivity as well as temperature compensated Specific Conductance. If Specific Conductance is selected, the Pro2030 uses the temperature and conductivity values associated with each measurement to calculate a specific conductance value compensated to a user selected reference temperature, see below. Additionally, the user can select the temperature coefficient from 0% to 4%.

Using the Pro2030's default reference temperature and temperature coefficient (25 °C and 1.91%), the calculation is carried out as follows:

$$\text{Specific Conductance (25°C)} = \frac{\text{Conductivity of sample}}{1 + 0.0191 * (T - 25)}$$

T = Temperature of the sample in °C

SPECIFIC CONDUCTANCE REFERENCE TEMPERATURE (SPC REF. TEMP.)

SPC Ref. Temp. (Specific Conductance Reference Temperature) is the reference temperature used to calculate Specific Conductance. The reference temperature range is 15 and 25 °C. The default value is 25 °C.

To change the reference temperature, highlight SPC Ref. Temp. and press enter to open the submenu. With the reference temperature highlighted, press enter to make the field adjustable. Next, use the up or down arrow key to increase or decrease the value. Press enter to save the new reference temperature. Next, highlight the ESC-Exit box and press enter to close the submenu.

SPECIFIC CONDUCTANCE TEMPERATURE COEFFICIENT (SPC %/°C)

SPC %/°C (Specific Conductance Temperature Coefficient) is the temperature coefficient used to calculate Specific Conductance. The coefficient range is 0.00 to 4.00. The default value is 1.91% which is based on KCl standards.

To change the temperature coefficient, highlight SPC %/°C and press enter to open the submenu. With the temperature coefficient highlighted, press enter to make the field adjustable. Next, use the up or down arrow key to increase or decrease the value. Press enter to save the new coefficient. Next, highlight the ESC-Exit box and press enter to close the submenu.

TDS CONSTANT

TDS Constant is a multiplier used to calculate an estimated TDS (Total Dissolved Solids) value from conductivity. The multiplier is used to convert Specific Conductance in mS/cm to TDS in g/L. The Pro2030's default value is 0.65. This multiplier is highly dependent on the nature of the ionic species present in the water sample. To be assured of moderate accuracy for the conversion, you must determine a multiplier for the water at your sampling site. Use the following procedure to determine the multiplier for a specific sample:

1. Determine the specific conductance of a water sample from the site;
2. Filter a sample of water from the site;
3. Completely evaporate the water from a carefully measured volume of the filtered sample to yield a dry solid;
4. Accurately weigh the remaining solid;
5. Divide the weight of the solid (in grams) by the volume of water used (in liters) to yield the TDS value in g/L for this site;
6. Divide the TDS value in g/L by the specific conductance of the water in mS/cm to yield the conversion multiplier. Be certain to use the correct units.

If the nature of the ionic species at the site changes between sampling studies, the TDS values will be in error. TDS cannot be calculated accurately from specific conductance unless the make-up of the chemical species in the water remains constant.

To change the TDS Constant in the Pro2030, highlight TDS Constant and press enter to open the submenu. With the TDS Constant highlighted, press enter to make the field adjustable. Next, use the up or down arrow key to increase or decrease the value. The input range is 0.30 to 1.00. Press enter to save the new TDS Constant. Next, highlight the ESC-Exit box and press enter to close the submenu.

TEMPERATURE UNITS

Highlight Temperature Units and press enter to open a submenu that allows you to change the temperature units displayed on the Run screen. Highlight the desired unit (Celsius or Fahrenheit) and press enter to enable. The enabled temperature unit will have an 'X' in the box next to it. Only one unit may be enabled at a time. Highlight the ESC-Exit box and press enter to save any changes and to close the Temperature Units submenu.

PRESSURE UNITS

Highlight Pressure Units and press enter to open a submenu that allows you to change the barometric pressure units displayed on the Run screen. Highlight the desired unit (mmHg, inHg, mbar, psi, or kPa) and press enter to enable. The enabled pressure unit will have an 'X' in the box next to it. Only one unit may be enabled at a time. Highlight the ESC-Exit box and press enter to save any changes and to close the Pressure Units submenu.

LANGUAGE

Highlight Language and press enter to open a submenu that allows you to change the language. Highlight the desired language (English, Spanish, German, or French) and press enter to enable. The enabled language will have an 'X' in the box next to it. Highlight ESC-Exit box and press enter to save any changes and to close the Language submenu.

The text in the boxes along the bottom of the Run screen will always be displayed in English regardless of the language enabled in the System Setup menu.

AUTO SHUTOFF

Auto Shutoff allows you to set the instrument to turn off automatically after a period of time. Use the up or down arrow keys to highlight Auto Shutoff, then press enter to open the submenu. Press enter while the minute field is highlighted to make it adjustable. Next, use the up or down arrow keys to adjust the shut off time from 0 to 60 minutes. Press enter to save the new shutoff time. Next, highlight the ESC-Exit box and press enter to close the submenu.

To disable Auto Shutoff, set the Time in Minutes to 0 (zero).

RESETTING THE SYSTEM SETUP MENU TO FACTORY DEFAULT

To reset the Pro2030 settings to factory default, press the down arrow key while in the System Setup menu until the Reset -  box is highlighted, then press enter. The instrument will ask you to confirm the reset. Highlight Yes and press enter to continue with the reset or highlight No and press enter to cancel the reset. A Factory Reset will not affect data saved in the instrument's memory.

The following will be set in the Pro2030 after performing a reset:

<i>Parameter</i>	<i>Reset Defaults</i>
DO Local%	Off
LDS (Last Digit Suppression)	Off
Quick DO Cal	Off
Audio	On
Contrast	Set to mid range
Dissolved Oxygen Sensor Type	Last Setting Confirmed
Dissolved Oxygen Membrane Type	Last Setting Confirmed
Dissolved Oxygen Auto Stable	Off (0.0 % Change and 10 seconds)
Dissolved Oxygen Units	mg/L and %
Conductivity Units	cond mS/cm and spc mS/cm
Conductivity Auto Stable	Off (0.0 % Change and 10 seconds)
SPC Reference Temperature	25°C
SPC Temperature Coefficient	1.91%/°C
TDS Constant	0.65
Temperature Units	°C
Pressure Units	mmHg
Language	English
Auto Shutoff	30 minutes
Dissolved Oxygen Calibration	Reset to 100% for enabled membrane and sensor.
Conductivity Calibration	Cell constant reset to 5.0
Barometer Calibration	Reset to factory default*

*It is recommended to perform a barometer and dissolved oxygen calibration after performing a reset.

CALIBRATION

TEMPERATURE

All Pro2030 cables have built-in temperature sensors. Temperature calibration is not required nor is it available.

BAROMETER

The barometer in the Pro2030 is calibrated at the factory. The barometer reading must be accurate to ensure accurate DO% calibrations and readings. If the barometer requires an adjustment, use the up or down arrow keys to highlight the barometer box along the bottom of the Run screen, then press enter. Next, use the up or down arrow keys to adjust the barometer reading to the local, true barometric pressure. Continually depress the up or down arrow key to change the barometer value more rapidly. Press enter to confirm and save the barometer adjustment.



Do not use a barometer value that is corrected to sea level. Laboratory barometer readings are usually “true” (uncorrected) values of air pressure and can be used “as is” for barometer calibration. Weather service readings are usually not “true”, i.e., they are corrected to sea level, and therefore cannot be used until they are “uncorrected”. An approximate formula for this “uncorrection” is:

$$\text{True BP} = [\text{Corrected BP}] - [2.5 * (\text{Local Altitude in ft above sea level}/100)]$$

Although the Pro2030 barometer range is 400.0 to 999.9 mmHg, you will be unable to adjust the value across the entire range. The barometer is very accurate and the instrument will not allow you to adjust the value drastically beyond what it is measuring.

DISSOLVED OXYGEN

The dissolved oxygen sensor can be easily calibrated with the press of two or three keys by enabling Quick DO Cal in the System Setup menu and following the Quick DO Calibration procedure.

Ensure the barometer is reading accurately before performing a Quick DO Cal, DO% or DO Local% calibration because these calibration procedures use the barometer reading during calibration. If the barometer reading is erroneous during a calibration, the dissolved oxygen measurements will be inaccurate.



It is not necessary to calibrate in both % and mg/L or ppm. Calibrating in % will simultaneously calibrate mg/L and ppm and vice versa. YSI recommends calibrating the dissolved oxygen sensor in % for both ease and accuracy.

QUICK DO CALIBRATION

Perform this calibration procedure when Quick DO Calibration is enabled in the System Setup menu.

1. Ensure the DO sensor has a good membrane with electrolyte installed. A good membrane is free of wrinkles, tears, fouling and air bubbles. Install the sensor guard onto the probe.
2. Moisten the sponge in the grey calibration/storage sleeve with a small amount of clean water and install it over the sensor guard. The sponge should only be moistened and the calibration/storage sleeve should not have excess water in it that could cause water droplets to get on the membrane. The storage sleeve ensures venting to the atmosphere.
3. Power the instrument on and, if using a Polarographic sensor, wait approximately 5 to 15 minutes for the storage chamber to become completely saturated and for the sensor to stabilize. If using a Galvanic sensor, wait approximately 5 to 10 minutes for the chamber to become completely saturated. Auto Shutoff should be disabled or set to at least 20 minutes. See System Setup menu for more information on adjusting the Auto Shutoff.
4. Ensure the barometer is reading accurately. If necessary, perform a barometer calibration.
5. Press and hold the Calibrate key for 3 seconds. Using the up or down arrow key, highlight Dissolved Oxygen and press enter. The Pro2030 will indicate 'Calibrating %DO' on the display. The instrument will automatically calibrate the sensor to the current barometric pressure. If DO Local% is enabled, the sensor will calibrate to 100%. This may take up to 2 minutes depending on the age of the sensor and membrane. You can press the Cal key at this time to cancel the calibration.
6. 'Calibration Successful' will display for a few seconds to indicate a successful calibration and then the instrument will return to the Run screen.
7. If the calibration is unsuccessful, an error message will display on the screen. Press the Cal key to exit the error message and return to the Run screen. See the Troubleshooting guide for possible solutions.

CALIBRATING IN PERCENT (DO%)

Perform this calibration procedure when Quick DO Cal is disabled in the System Setup menu.

1. Perform steps 1-4 of the Quick DO Calibration procedure.
2. Press and hold the Calibrate key for 3 seconds. Highlight Dissolved Oxygen and press enter. Next, highlight % and press enter.
3. The Pro2030 will display the current DO% and temperature readings along with the % calibration value. The % calibration value is based on the barometer reading.
4. Wait at least 3 seconds, then, once the DO% and temperature readings are stable, press enter to complete the calibration. Or, press the Cal key to cancel the calibration.
5. 'Calibration Successful' will display for a few seconds to indicate a successful calibration and then the instrument will return to the Run screen.
6. If the calibration is unsuccessful, an error message will display on the screen. Press the Cal key to exit the calibration error message and return to the Run screen. See the Troubleshooting guide for possible solutions.

CALIBRATING IN PERCENT (DO LOCAL% ENABLED)

Perform this calibration procedure when DO Local% is enabled in the System Setup menu.

1. Perform steps 1-4 of the Quick DO Calibration procedure.
2. Press and hold the Cal key for 3 seconds. Highlight Dissolved Oxygen and press enter.
3. %Local will automatically be highlighted, press enter. The Pro2030 will display the current DO% and temperature readings along with the % calibration value. The % calibration value will always be 100% for DO Local%.
4. Wait at least 3 seconds, then, once the DO% and temperature readings stabilize, press enter to complete the calibration. Or, press the Cal key to cancel the calibration.
5. 'Calibration Successful' will display for a few seconds to indicate a successful calibration and then the instrument will return to the Run screen.
6. If the calibration is unsuccessful, an error message will display on the screen. Press the Cal key to exit the calibration error message and return to the Run screen. See the Troubleshooting guide for possible solutions.

CALIBRATING IN MG/L OR PPM

1. Power the instrument on and place the sensor into a sample that has been titrated to determine the dissolved oxygen concentration. The sample should cover the two holes of the conductivity sensor that are located near the cable, see figure 8. During the calibration, continuously stir or move the probe through the sample at a rate of at least 6 inches (15.5 cm) per second if using a yellow membrane or at least 3 inches (7.7 cm) per second if using a blue membrane. A stir plate may be helpful for this calibration procedure.
2. Allow the dissolved oxygen and temperature readings to stabilize. This may take 5 to 15 minutes, depending on the type and condition of the sensor.
3. Press the Cal key. Highlight Dissolved Oxygen and press enter.
4. Highlight mg/L or ppm depending on what is enabled in the System Setup menu and press enter.
5. Use the up and down arrow keys to adjust the mg/L (ppm) reading to the value of the titrated sample. Press enter to confirm the value and complete the calibration or press the Cal key to cancel the calibration.
6. 'Calibration Successful' will display for a few seconds to indicate a successful calibration and then the instrument will return to the Run screen.
7. If the calibration is unsuccessful, an error message will display on the screen. Press the Cal key to exit the calibration error message and return to the Run screen. See the Troubleshooting guide for possible solutions.

CONDUCTIVITY CALIBRATION

Ensure the conductivity sensor is clean and dry before performing a conductivity, specific conductance or salinity calibration.



It is not necessary to calibrate conductivity, specific conductance and salinity. Calibrating one of these parameters will simultaneously calibrate the others. YSI recommends calibrating specific conductance for greatest ease.

CALIBRATING SPECIFIC (SP.) CONDUCTANCE OR CONDUCTIVITY

Note: When calibrating Specific Conductance, the Pro2030 uses the factory default values for the Specific Conductance Reference Temperature and the Specific Conductance Temperature Coefficient regardless of what is configured in the System Setup Menu. The default value for the Reference Temperature is 25°C

and the default value for the Temperature Coefficient is 1.91%/°C. It is important to note that the Temperature Coefficient of a calibration solution is dependent on the contents of the solution. Therefore, YSI recommends using a traceable calibration solution made of KCl (potassium chloride) when calibrating Specific Conductance since these solutions typically have a Temperature Coefficient of 1.91%/°C. Additionally, be sure to enter the value of the solution as it is listed for 25°C when calibrating Specific Conductance.

1. Fill a clean container (i.e. plastic cup or glass beaker) with fresh, traceable conductivity calibration solution and place the sensor into the solution. The solution must cover the holes of the conductivity sensor that are closest to the cable (figure 8). Ensure the entire conductivity sensor is submerged in the solution or the instrument will read approximately half the expected value. Gently move the probe up and down to remove any air bubbles from the conductivity sensor.

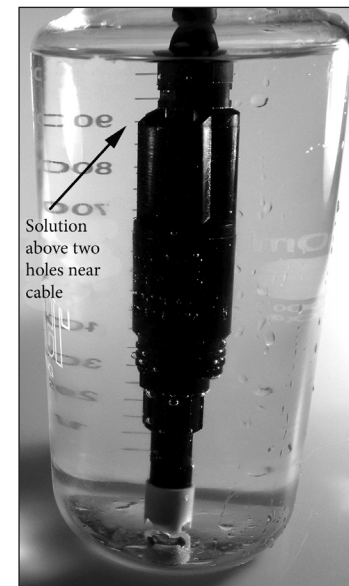

Figure 8, solution above two holes near cable.

2. Turn the instrument on and allow the conductivity and temperature readings to stabilize. Press the Cal key. Highlight Conductivity and press enter. Next, highlight the desired calibration method, Sp. Conductance or Conductivity, and press enter.
3. Highlight the units you wish to calibrate, either uS/cm or mS/cm, and press enter. 1 mS = 1,000 uS. Next, use the up or down arrow key to adjust the value on the display to match the value of the conductivity calibration solution. If calibrating conductivity, it is necessary to look

up the value of the solution at the current temperature and enter that value into the Pro2030. Most conductivity solutions are labeled with a value at 25°C. If calibrating specific conductance, enter the value listed for 25°C. Depressing either the up or down arrow key for 5 seconds will move the changing digit one place to the left. The Pro2030 will remember the entered calibration value and display it the next time a conductivity calibration is performed.

4. Press enter to complete the calibration. Or, press Cal to cancel the calibration and return to the Run screen.
5. 'Calibration Successful' will display for a few seconds to indicate a successful calibration and then the instrument will return to the Run screen.
6. If the calibration is unsuccessful, an error message will display on the screen. Press the Cal key to exit the calibration error message and return to the Run screen. See the Troubleshooting guide for possible solutions.

CALIBRATING IN SALINITY

1. Fill a clean container (i.e. plastic cup or glass beaker) with fresh, traceable salinity calibration solution and place the sensor into the solution. The solution must cover the holes of the conductivity sensor that are closest to the cable (figure 8). Ensure the entire conductivity sensor is submerged in the solution or the instrument will read approximately half the expected value. Gently move the probe up and down to remove any air bubbles from the conductivity sensor.
2. Turn the instrument on and allow the conductivity and temperature readings to stabilize. Press the Cal key. Highlight Conductivity and press enter. Next, highlight Salinity and press enter.
3. Use the up or down arrow key to adjust the value on the display to match the value of the salinity solution. Depressing either the up or down arrow key for 5 seconds will move the changing digit one place to the left. The Pro2030 will remember the entered calibration value and display it the next time a salinity calibration is performed.
4. Press enter to complete the calibration. Or, press Cal to cancel the calibration and return to the Run screen.
5. 'Calibration Successful' will display for a few seconds to indicate a successful calibration and then the instrument will return to the Run screen.
6. If the calibration is unsuccessful, an error message will display on the screen. Press the Cal key to exit the calibration error message and return to the Run screen. See the Troubleshooting guide for possible solutions.

TAKING MEASUREMENTS

Before taking measurements, be sure the instrument has been calibrated to ensure the most accurate readings. Turn the instrument on and wait 5-15 minutes if using a polarographic sensor. Install the sensor guard to protect the sensor and membrane. Place the probe in the sample to be measured and give the probe a quick shake to release any air bubbles. Be sure the conductivity sensor is completely submerged in the sample. The two holes near the cable should be covered by the sample for accurate conductivity readings (figure 8).

Allow the temperature readings to stabilize. Next, stir the probe in the sample to overcome the stirring dependence of the dissolved oxygen sensor. The dissolved oxygen sensor requires at least 6 inches (16 cm) per second of water movement if using the yellow membrane and 3 inches (7.62 cm) per second of water movement if using the blue membrane. The required sample movement can be achieved by the natural flow of the stream, physically stirring the probe in the sample or a combination of the two. Once the values plateau and stabilize you may record the measurement and/or store the data set. The dissolved oxygen reading will drop over time if stirring or movement is ceased. If placing the DO sensor into a stream or fast flowing waters it is best to place it perpendicular to the flow and not facing into the flow.

If using the DO sensor near an aeration device, it is helpful to make sure air bubbles do not burst on the membrane since that may cause unstable DO readings. You should be able to prevent this by pointing the sensor upwards so it's facing the sky and twist tying, zip tying or rubber banding the bulkhead to the cable. Essentially, making a simple curve to the cable without bending or breaking the cable will allow you to lower the sensor into the aerated sample while the sensor points skyward and air bubbles are no longer bursting on the membrane surface.

SAVING AND VIEWING DATA

The Pro2030 can store 50 data sets in non-volatile memory for later viewing. A data set includes the values currently on the display, i.e. temperature, dissolved oxygen and two conductivity parameters. Each data point is referenced with a data set number, 01 through 50.

SAVING DATA



The Pro2030 can not communicate to a PC via a Pro Series communications saddle. Connecting the Pro2030 to a communication saddle may cause erratic instrument behavior.

From the Run screen, use the up or down arrow keys to highlight the Save box and press enter to save the current readings. The instrument will indicate the data set is saved and display the saved data set's number (figure 9).

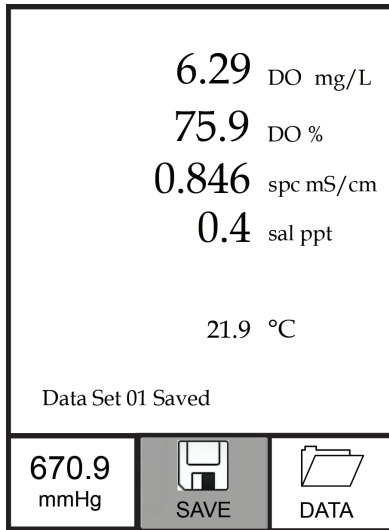

Figure 9, data set saved.

The instrument will display 'Memory Full' if all 50 data sets have been saved and you attempt to save another data set.

VIEWING AND ERASING SAVED DATA - DATA MODE

Data mode allows you to view and erase saved data. From the Run screen, use the up or down arrow keys to highlight Data and press enter to access Data mode. Note that the function boxes at the bottom of the display are different in Data mode (figure 10).

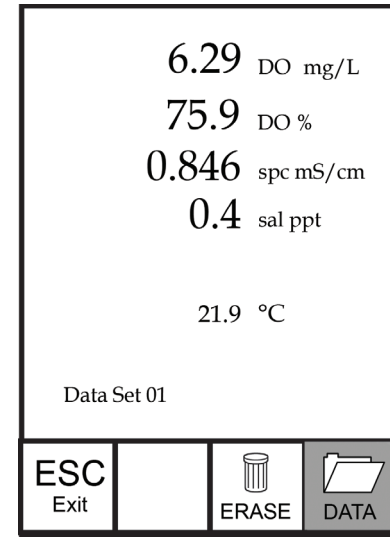

Figure 10, Data mode.

VIEWING DATA

Once in Data mode, use the up and down arrow keys to view saved data sets in sequential order or press enter to access the bottom functions. After accessing the bottom functions, highlight the Data box and press enter to regain access to viewing data. The data set displayed is indicated by the data set number, 01 through 50.

ERASING DATA

While viewing saved data, press the enter key to access the function boxes at the bottom of the display. Next, use the up or down arrow keys to highlight Erase, then press enter. The instrument will give you the option to erase one data set or all data sets (figure 11).

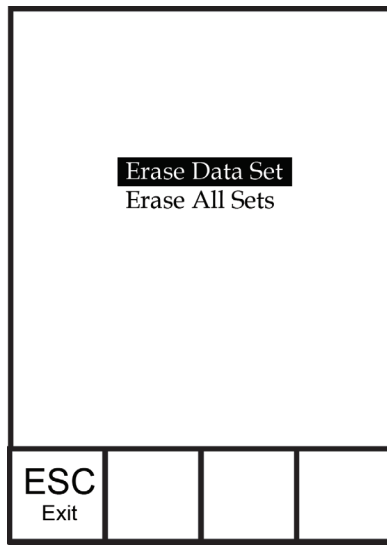

Figure 11, Erase data mode.

Use the up or down arrow key to select Erase Data Set, Erase All Sets or the ESC-Exit function box, then press enter to confirm.

Select ESC-Exit and press enter to exit Erase mode without erasing any data.

Select Erase Data Set and press enter to erase the data set that was displayed before entering Erase mode. For example, if data set 12 was displayed before entering erase mode, and Erase Data Set is selected, Data Set 12 will be erased from memory and the data sets AFTER that number will move up to keep them sequential. For example, if there are 15 records and number 12 is erased then 13 becomes 12, 14 becomes 13, and 15 becomes 14. The instrument will return to Data mode after erasing one data set.

Select Erase All Data Sets and press enter to clear the Pro2030 memory and return to Data mode.

EXITING DATA MODE

While in Data mode, press enter to access the bottom functions. Next, highlight the ESC-Exit box and press enter to return to the Run screen.

CARE, MAINTENANCE AND STORAGE

This section describes the proper procedures for care, maintenance and storage of the sensors. The goal is to maximize their lifetime and minimize down-time associated with improper sensor usage.

GENERAL MAINTENANCE

GENERAL MAINTENANCE - GASKET AND O-RINGS

The instrument utilizes a gasket and o-rings as seals to prevent water from entering the battery compartment and the sensor port. Following the recommended procedures will help keep the instrument functioning properly.

If the gasket, o-rings and sealing surfaces are not maintained properly, it is possible that water can enter the battery compartment and/or sensor port of the instrument. If water enters these areas, it can severely damage the battery terminals or sensor port causing loss of battery power, false readings and corrosion to the sensors or battery terminals. Therefore, when the battery compartment lid is removed, the gasket that provides the seal should be carefully inspected for contamination (i.e. debris, grit, etc.) and cleaned with water and mild detergent if necessary.

The same inspection should be made of the o-rings associated with the dissolved oxygen sensor connector if and when the DO sensor is removed. If no dirt or damage to the o-rings is evident, then they should be lightly greased with the o-ring grease provided without removing them from their groove. However, if there is any indication of damage, the sensor o-ring should be replaced with an identical o-ring.

To remove the DO sensor o-rings:

Use a small, flat-bladed screwdriver or similar blunt-tipped tool to remove the o-ring from its groove near the sensor connector. Check the o-ring and the groove for any excess grease or contamination. If contamination is evident, clean the o-ring and nearby plastic parts with lens cleaning tissue or equivalent lint-free cloth. Alcohol can be used to clean the plastic parts, but use only water and mild detergent on the o-ring itself. Also, inspect the o-rings for nicks and imperfections.



Using alcohol on o-rings may cause a loss of elasticity and may promote cracking. Do not use a sharp object to remove the o-rings. Damage to the o-ring or the groove may result.

Before re-installing the DO sensor o-rings, make sure to use a clean workspace, clean hands and avoid contact with anything that may leave fibers on the o-ring or grooves. Even a very small amount of contamination (hair, grit, etc.) may create a path for water intrusion or contamination.

To re-install the DO sensor o-rings:

Place a small amount of o-ring grease between your thumb and index finger. (More grease is not better!)

Draw the o-ring through the grease while pressing the fingers together to place a very light covering of grease on the o-ring. Place the o-ring into its groove ensuring that it does not twist or roll.

Use the previously grease-coated finger to once again lightly go over the surface of the o-ring.

i *Do not over-grease the o-rings. The excess grease may collect grit particles that can compromise the seal. Excess grease can also cause the waterproofing capabilities of the o-ring to diminish, potentially causing leaks. If excess grease is present, remove it using a lens cloth or lint-free cloth.*

GENERAL MAINTENANCE - DO SENSOR PORT

It is important that the entire sensor connector end be dry when installing, removing or replacing the sensor. This will prevent water from entering the port. Once the DO sensor is removed, examine the connector inside the port. If any moisture is present, use compressed air to completely dry the connector or let it air dry. If the connector is corroded, contact YSI Technical Support or the YSI authorized dealer where you purchased the instrument.

i *Remove sensors upside down (facing the ground) to help prevent water from entering the port upon removal.*

SENSOR MAINTENANCE

SENSOR MAINTENANCE - TEMPERATURE

You must keep the temperature sensor free of build up. Other than that, no additional maintenance is required. A toothbrush can be used to scrub the temperature sensor if needed.

SENSOR MAINTENANCE - CONDUCTIVITY

The openings that allow sample access to the conductivity electrodes should be cleaned regularly. The small cleaning brush included in the Maintenance Kit is intended for this purpose. Dip the brush in clean water and insert it into each hole 10 to 12 times. In the event that deposits have formed on the electrodes, it may be necessary to use a mild detergent (laboratory grade soap or bathroom foaming tile cleaner) with the brush. Rinse thoroughly with clean water, then check the response and accuracy of the conductivity cell with a calibration solution.

SENSOR MAINTENANCE - DISSOLVED OXYGEN

Membrane Cap Installation

The DO sensor (Polarographic or Galvanic) is shipped with a protective red cap that needs to be removed before using. Remove the red protective cap or used cap membrane and replace it with a new cap membrane following these instructions:

Remove the sensor guard to access the sensor.

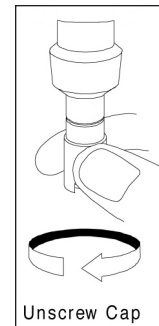

Remove the protective red cap by pulling it straight off the sensor. Or, unscrew and remove the used cap membrane by holding the sensor while unscrewing the cap membrane. Discard the used cap membrane.

Thoroughly rinse the sensor tip with distilled or deionized water.

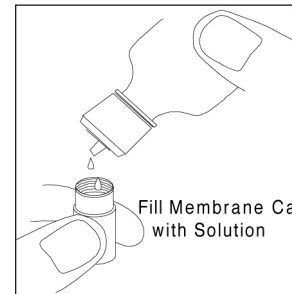

Fill a new cap membrane 3/4 full with electrolyte solution that has been prepared according to the directions on the bottle. Be very careful not to touch the membrane surface.

Lightly tap the side of the cap membrane to release bubbles that may be trapped.

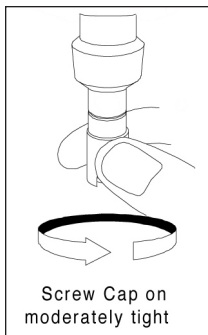

Thread the cap membrane onto the sensor. It is normal for a small amount of electrolyte to overflow.

Replace the sensor guard.

Polarographic Sensors – Model # 605203

The cap membrane and KCl (potassium chloride) electrolyte solution should be changed every 2-4 weeks during regular use. In addition, the electrolyte solution and membrane should be changed if (a) bubbles are visible under the membrane; (b) significant deposits of dried electrolyte are visible on the membrane; and (c) if the sensor shows unstable readings or other sensor-related symptoms.

During membrane changes, examine the gold cathode at the tip of the sensor and the silver anode along the shaft of the sensor (figure 12). If either the silver anode is black in color or the gold cathode is dull, the sensor may need resurfaced using the 400 grit wet/dry sanding discs included in the membrane kit. Do not sand the electrode every membrane change as this is not routine maintenance. In fact, visually, the anode may appear tarnished and operate properly. YSI recommends using the sanding disc if the sensor has difficulty stabilizing or calibrating after a regular membrane change.

To clean and resurface the sensor, follow the instructions on the next page.

Gold Cathode

For correct sensor operation, the gold cathode (figure 12) must be textured properly. It can become tarnished or plated with silver after extended use. Never use chemicals or abrasives that have not been recommended or supplied by YSI.

First dry the sensor tip completely with lens cleaning tissue. Wet a sanding disc and place it face up in the palm of your hand. Next, with your free hand, hold the sensor in a vertical position, tip down. Place the sensor tip directly down on the sanding disc and twist it in a circular motion to sand the gold cathode. The goal is to sand off any build-up and to lightly scratch the cathode to provide a larger surface area for the electrolyte solution under the membrane. Usually, 3 to 4 twists of the sensor are sufficient to remove deposits and for the gold to appear to have a matte finish. Rinse the sensor thoroughly with distilled or deionized

water and wipe the gold cathode with a wet paper towel before putting on a new cap membrane. If the cathode remains tarnished, contact YSI Technical Support or the YSI authorized dealer where you purchased the instrument.

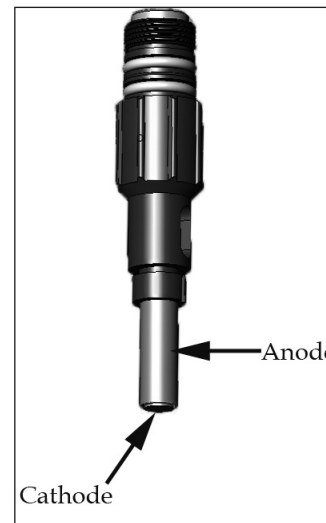

Figure 12, DO sensor with membrane removed.

Silver Anode

After extended use, a thick layer of Silver Chloride (AgCl) builds up on the silver anode (figure 12) reducing the sensitivity of the sensor. The anode must be cleaned to remove this layer and restore proper performance. The cleaning can be chemical and/or mechanical:

Mechanical cleaning: In order to sand the silver anode along the shaft of the sensor, simply hold the sensor in a vertical position. Wet the sanding disc and gently wrap it around the sensor and twist it a few times to lightly sand the anode (the goal is to simply sand off any build-up without scratching or removing layers of the anode itself). Usually, 3 to 4 twists of the sanding disc are sufficient to remove deposits.

After completing the sanding procedure, repeatedly rinse the electrode with distilled or deionized water and wipe with lens cleaning tissue to remove any grit left by the sanding disc. Thoroughly rinse the entire tip of the sensor with distilled or deionized water and install a new membrane.



IMPORTANT: Be sure to: (1) Use only the fine sanding discs provided and (2) Sand as mentioned in the above procedures. Not adhering to either of these instructions can damage the electrodes.

Chemical cleaning: Remove the cap membrane and rinse the sensor with deionized or distilled water. Soak the sensing section of the sensor in a 14% ammonium hydroxide solution for 2 to 3 minutes or in a 3% ammonia solution overnight for 8-12 hours (most household ammonia cleaners are typically around 3%). Rinse heavily in cool tap water followed by a thorough rinsing with distilled or deionized water. The anode should then be thoroughly wiped with a wet paper towel to remove the residual layer from the anode. Trapping residual ammonia under the new membrane cap can quickly tarnish the electrode and/or give false readings and should therefore be avoided.

After performing a chemical cleaning on the polarographic sensor, lightly sand the cathode and anode following the mechanical cleaning procedures described previously.



Chemical cleaning should be performed as infrequently as possible. First attempt a membrane change and recalibrate. If a new membrane does not resolve the problem, then proceed with cleaning.

If this procedure is unsuccessful, as indicated by improper sensor performance, contact YSI Technical Support or the YSI authorized dealer where you purchased the instrument.

Galvanic Sensors – Model # 605202

YSI recommends that the Sodium Chloride (NaCl) electrolyte solution and cap membrane be changed every 2-4 weeks during regular use. In addition, the electrolyte solution and membrane should be changed if (a) bubbles are visible under the membrane; (b) significant deposits of dried electrolyte are visible around the membrane; and (c) if the sensor shows unstable readings or other sensor-related symptoms.

The Galvanic dissolved oxygen sensor is continuously reducing oxygen even when the instrument is turned off. This factor allows the sensor to be used with no warm-up period as soon as the instrument is powered on. However, because the sensor is “on” all the time, some solid from the oxidation of the zinc anode will form in the electrolyte within 1-2 weeks of activation. Small amounts of the solid will generally cause no performance problems, but excessive amounts may result in jumpy dissolved oxygen readings. The rate of solid formation is dependent on the type of membrane installed. The formation of solids typically form more rapidly with 5913 (1.25 mil PE) membrane, and less rapid with 5914 (2 mil PE) membranes.



The Galvanic electrolyte solution will appear milky white after use but this will not affect the accuracy of the sensor unless there is excessive build up. The color change is acceptable and normal as long as DO readings remain stable.

At the time the cap membrane is changed, YSI recommends that you rinse the anode and cathode (figure 12) with distilled or deionized water and wipe with a clean paper towel. If white deposits are evident on the anode after cleaning, YSI recommends that you remove this material by sanding the anode with the 400 grit wet/dry sanding disc included in the membrane kit following the “Mechanical Cleaning” instructions under the Polarographic Silver Anode maintenance section of this manual. If there are deposits on the cathode, sand the cathode with the 400 grit wet/dry sanding disc following the maintenance instructions listed in this manual for the Polarographic Gold Cathode.



IMPORTANT: Be sure to: (1) Use only the fine sanding discs provided and (2) Sand as mentioned in the above procedures. Not adhering to either of these instructions can damage the electrodes.

WARNING: Do not perform the Polarographic chemical cleaning on a Galvanic sensor.

If this procedure is unsuccessful, as indicated by improper sensor performance, contact YSI Technical Support or the YSI authorized dealer where you purchased the instrument.

SENSOR STORAGE

SHORT TERM STORAGE

The instrument is supplied with a grey calibration/storage sleeve that slides over the probe guard. The sleeve is used for short-term storage (less than 30 days). Be sure to keep a small amount of moisture (clean tap water) on the sponge in the sleeve during storage. This is simply done to maintain a 100% water saturated air environment which is ideal for short-term sensor storage. The sensors should not be submerged in water.

LONG TERM STORAGE

The dissolved oxygen and conductivity sensors should be stored long term in a dry state. When storing for more than 30 days, remove the cap membrane and thoroughly rinse the dissolved oxygen sensor with distilled or deionized water. Once the sensor has been rinsed either blow it dry with compressed air or allow

to air dry completely. Next, use a new clean, dry cap membrane to screw over the sensor. This will keep the sensor dry and protect the anode and cathode during storage. Ensure the conductivity sensor is clean and dry.

After storing for a long period of time, it is necessary to “condition” the dissolved oxygen sensor by installing a new membrane with electrolyte solution.

Long Term Storage Temperature: -5 to 70°C (23 to 158°F)

TROUBLESHOOTING

<i>Symptom</i>	<i>Possible Solution</i>
Instrument will not turn on, a battery symbol appears, or “Critical Shutdown” displays on the screen.	<ol style="list-style-type: none"> 1. Low battery voltage, replace batteries. 2. Batteries installed incorrectly, check battery polarity. 3. Return system for service.
Barometer reads over/undr and calibrating Dissolved Oxygen results in a Barometric Pressure Over/Undr error message.	<ol style="list-style-type: none"> 1. Barometer failure, return system for service
Temperature values display Over or Undr on Run screen.	<ol style="list-style-type: none"> 1. Sample temperature is less than -5° C or more than +55°C. Increase or decrease the sample temperature to bring within the allowable range. 2. Contact YSI Tech Support.
Instrument will not calibrate dissolved oxygen; instrument displays “Calibration Over”, “Calibration Under”, or “Unstable Reading” during calibration.	<ol style="list-style-type: none"> 1. Verify barometer reading. 2. Verify correct sensor and membrane type selection in the System Setup menu. 3. Calibration sleeve may not be 100% water saturated, ensure sponge is moistened. 4. Ensure adequate sample movement if performing mg/L or ppm calibration. 5. Allow sufficient stabilization time for dissolved oxygen and temperature AND wait at least 3 seconds before confirming a DO% or DO Local% calibration. 6. Replace membrane and electrolyte. 7. Clean sensor electrodes. 8. Contact YSI Tech Support.

<i>Symptom</i>	<i>Possible Solution</i>
DO readings are inaccurate.	<ol style="list-style-type: none"> 1. Verify correct sensor/membrane type selection in the System Setup menu. 2. Verify conductivity readings are accurate. Conductivity is used in the calculation of mg/L. 3. Verify temperature readings are accurate. 4. Sample temperature should be between 0 and 45 °C, the temperature compensation range for DO mg/L. 5. DO sensor not properly calibrated, recalibrate the sensor. 6. Replace membrane and electrolyte. Recalibrate. 7. Clean sensor electrodes. 8. Contact YSI Tech Support.
Dissolved Oxygen values display Over or Undr on Run screen.	<ol style="list-style-type: none"> 1. Verify correct sensor/membrane type selection in the System Setup menu. 2. If using a polarographic sensor, allow instrument to warm up for 5 – 15 minutes before use. 3. Sample dissolved oxygen concentration is more than 50 mg/L or 500%, or less than -0.02 mg/L or -0.3%. 4. Verify conductivity readings are accurate. 5. Verify temperature readings are accurate. 6. Replace membrane and electrolyte. Recalibrate. 7. Clean sensor electrodes. 8. Contact YSI Tech Support.

<i>Symptom</i>	<i>Possible Solution</i>
Instrument will not calibrate the Conductivity sensor; instrument displays “Calibration Over”, “Calibration Under”, or “Unstable Reading” during calibration.	<ol style="list-style-type: none"> 1. Ensure the conductivity sensor is clean. Follow the cleaning procedures in the Care, Maintenance and Storage section of this manual. 2. Verify the calibration solution is above the two holes near the cable, see figure 8. 3. Verify the calibration solution is not expired or contaminated. Try a new bottle of solution. 4. Ensure you are entering in the correct value for the solution according to the measurement units. 1 mS = 1,000 uS. 5. Allow sufficient stabilization time for conductivity and temperature AND wait at least 3 seconds before confirming a calibration. 6. Contact YSI Tech Support.
Conductivity readings are inaccurate.	<ol style="list-style-type: none"> 1. Ensure the conductivity sensor is clean. Follow the cleaning procedures in the Care, Maintenance and Storage section of this manual. 2. Verify the sample is above the two holes near the cable, see figure 8. 3. Verify calibration. 4. Verify temperature readings are accurate. 5. Verify the correct units are setup in the System Setup menu, i.e. uS vs mS and Conductivity vs. Specific Conductance. 6. Contact YSI Tech Support.
Conductivity values display Over or Undr on Run screen.	<ol style="list-style-type: none"> 1. Ensure the conductivity sensor is clean. Follow the cleaning procedures in the Care, Maintenance and Storage section of this manual. 2. Verify the sample is above the two holes near the cable, see figure 8 3. Verify calibration. 4. Verify temperature readings are accurate. 5. Sample conductivity is outside the measurement range of the instrument, i.e. 0-200 mS. 6. Contact YSI Tech Support.

SPECIFICATIONS

These specifications represent typical performance and are subject to change without notice. For the latest product specification information, please visit YSI’s website at www.ysi.com or contact YSI Tech Support.

<i>Parameter</i>	<i>Range</i>	<i>Resolution</i>	<i>Accuracy</i>
Temperature	-5 to 55°C*	0.1°C	± 0.3°C
Dissolved Oxygen	0 to 200% air saturation	1% or 0.1%, user selectable	± 2% of the reading or ± 2% air saturation, whichever is greater
	200 to 500% air saturation	1% or 0.1%, user selectable	± 6% of the reading
	0 to 20 mg/L	0.1 or 0.01 mg/L, user selectable	±2% of the reading or ± 0.2 mg/L, whichever is greater
	20 to 50 mg/L	0.1 or 0.01 mg/L, user selectable	±6% of the reading
Conductivity	0-500 uS/cm 0-5 mS/cm 0-50 mS/cm 0-200 mS/cm (auto ranging)	0.0001 to 0.1 mS/cm; 0.1 to 0 uS/cm (range dependent)	Instrument only: ± 0.5% of the reading or 1 uS/cm, whichever is greater. Instrument with 1 or 4 meter cables: ± 1.0% of the reading or 1 uS/cm, whichever is greater. Instrument with 10, 20, or 30 meter cables: ± 2.0% of the reading or 1 uS/cm, whichever is greater.
Salinity	0 to 70 ppt	0.1 ppt	± 1.0% of the reading or ± 0.1 ppt, whichever is greater.
Total Dissolved Solids (TDS)	0 to 100 g/L. TDS Constant range: 0.3 to 1.00 (0.65 default)	0.0001 to 0.1 g/L (range dependent)	Dependent on accuracy of temperature, conductivity and TDS Constant.
Barometer	500.0 to 800.0 mmHg**	0.1 mmHg	±5 mmHg within 15°C of calibration temperature

* Automatic dissolved oxygen temperature compensation range is -0 to 45 °C

** Available barometer units include: mmHg, inHg, mbars, psi, or KPa

ACCESSORIES / PART NUMBERS

<i>Part Number</i>	<i>Description</i>
6052030	Pro2030 Instrument
6262030-1, -4, -10, -20, or -30	1, 4, 10, 20, 30-meter cable assembly*
605202	Galvanic Dissolved Oxygen Sensor
605203	Polarographic Dissolved Oxygen Sensor
603077	Flow cell
603056	Flow cell mounting spike
603075	Carrying case, soft-sided
603074	Carrying case, hard-sided
603069	Belt clip
063517	Ultra clamp for instrument
063507	Tripod for instrument
603062	Cable management kit, included with all cables longer than 1 meter.
605978	Cable weight, 4.9 oz, stackable
603070	Shoulder strap
605306	5908 membrane kit, yellow 1.25 polyethylene for polarographic sensors
605307	5909 membrane kit, blue 2.0 polyethylene for polarographic sensors
605913	5913 membrane kit, yellow 1.25 polyethylene for galvanic sensors
605914	5914 membrane kit, blue 2.0 polyethylene for galvanic sensors
060907	Conductivity Calibration Solution, 1,000 µS/cm. 1 box of 8 pints.
060911	Conductivity Calibration Solution, 10,000 µS/cm. 1 box of 8 pints.
060660	Conductivity Calibration Solution, 50,000 µS/cm. 1 box of 8 pints.
065274	Conductivity Calibration Solution, 100,000 µS/cm. 1 box of 8 pints.

*All cables include a temperature and conductivity sensor. The dissolved oxygen sensor is sold separately.

DECLARATION OF CONFORMITY

The undersigned hereby declares on behalf of the named manufacturer under our sole responsibility that the listed product conforms to the requirements for the listed European Council Directive(s) and carries the CE mark accordingly.

<i>Manufacturer:</i>	YSI Incorporated 1725 Brannum Lane Yellow Springs, OH 45387 USA
<i>Product Name:</i>	Pro2030 Water Quality Instrument
<i>Model Numbers</i>	
<i>Instrument/Accessory:</i>	Pro2030 (6052030)
<i>Probe/Cable Assemblies:</i>	6052030-1, -4, -10, -20, and -30
<i>Conforms to the following:</i>	
<i>Directives:</i>	IEC 61326-1:2005 RoHS 2002/95/EC WEEE 2002/96/EC
<i>Harmonized Standards:</i>	• EN61326-1:2006 (IEC 61326-1:2005) Emission & Immunity
<i>Supplementary Information:</i>	All performance met the operation criteria as follows: 1. ESD, IEC 61000-4-2:2001, Performance Criterion B 2. Radiated Immunity, IEC 61000-4-3, Performance Criterion A 3. Electrical Fast Transient (EFT), IEC 61000-4-4:2004, +Corr. 1:2006 + Corr. 2:2007, Performance Criterion B 4. Radio Frequency, Continuous Conducted Immunity, IEC61000-4-6, Performance Criterion A 5. RF Emissions, EN 61326-1:2006 (IEC61326-1:2005) Class B
<i>Authorized EU Representative</i>	YSI Hydrodata Ltd Unit 2 Focal Point, Lacerta Court, Works Road Letchworth, Hertfordshire, SG6 1FJ UK



Signed: Lisa M. Abel
Title: Director of Quality

Date: 07 July 2010

RECYCLING

YSI is committed to reducing the environmental footprint in the course of doing business. Even though materials reduction is the ultimate goal, we know there must be a concerted effort to responsibly deal with materials after they've served a long, productive life-cycle. YSI's recycling program ensures that old equipment is processed in an environmentally friendly way, reducing the amount of materials going to landfills.

- Printed Circuit Boards are sent to facilities that process and reclaim as much material for recycling as possible.
- Plastics enter a material recycling process and are not incinerated or sent to landfills.
- Batteries are removed and sent to battery recyclers for dedicated metals.

When the time comes for you to recycle, follow the easy steps outlined at www.ysi.com.

BATTERY DISPOSAL

The Pro2030 is powered by alkaline batteries which the user must remove and dispose of when the batteries no longer power the instrument. Disposal requirements vary by country and region, and users are expected to understand and follow the battery disposal requirements for their specific locale.

CONTACT INFORMATION

ORDERING AND TECHNICAL SUPPORT

Telephone: 800 897 4151 (USA)
+1 937 767 7241 (Globally)
Monday through Friday, 8:00 AM to 5:00 ET

Fax: +1 937 767 9353 (orders)
+1 937 767 1058 (technical support)

Email: environmental@ysi.com
Mail: YSI Incorporated
1725 Brannum Lane
Yellow Springs, OH 45387 USA

Internet: www.ysi.com

When placing an order please have the following available:

- 1.) YSI account number (if available)
- 2.) Name and phone number
- 3.) Purchase Order or Credit Card number
- 4.) Model Number or brief description
- 5.) Billing and shipping addresses
- 6.) Quantity

SERVICE INFORMATION

YSI has authorized service centers throughout the United States and Internationally. For the nearest service center information, please visit www.ysi.com and click 'Support' or contact YSI Technical Support directly at 800-897-4151 (+1 937-767-7241).

When returning a product for service, include the Product Return form with cleaning certification. The form must be completely filled out for a YSI Service Center to accept the instrument for service. The form may be downloaded from www.ysi.com by clicking on the 'Support'.

APPENDIX A-DO% CALIBRATION VALUES

Calibration Value	Pressure			
D.O. %	in Hg	mmHg	kPa	mbar
101%	30.22	767.6	102.34	1023.38
100%	29.92	760.0	101.33	1013.25
99%	29.62	752.4	100.31	1003.12
98%	29.32	744.8	99.30	992.99
97%	29.02	737.2	98.29	982.85
96%	28.72	729.6	97.27	972.72
95%	28.43	722.0	96.26	962.59
94%	28.13	714.4	95.25	952.46
93%	27.83	706.8	94.23	942.32
92%	27.53	699.2	93.22	932.19
91%	27.23	691.6	92.21	922.06
90%	26.93	684.0	91.19	911.93
89%	26.63	676.4	90.18	901.79
88%	26.33	668.8	89.17	891.66
87%	26.03	661.2	88.15	881.53
86%	25.73	653.6	87.14	871.40
85%	25.43	646.0	86.13	861.26
84%	25.13	638.4	85.11	851.13
83%	24.83	630.8	84.10	841.00
82%	24.54	623.2	83.09	830.87
81%	24.24	615.6	82.07	820.73
80%	23.94	608.0	81.06	810.60
79%	23.64	600.4	80.05	800.47
78%	23.34	592.8	79.03	790.34
77%	23.04	585.2	78.02	780.20
76%	22.74	577.6	77.01	770.07
75%	22.44	570.0	75.99	759.94
74%	22.14	562.4	74.98	749.81
73%	21.84	554.8	73.97	739.67
72%	21.54	547.2	72.95	729.54

APPENDIX B-OXYGEN SOLUBILITY TABLE

Solubility of Oxygen in mg/L in Water Exposed to Water-Saturated Air at 760 mm Hg Pressure.

Salinity = Measure of quantity of dissolved salts in water.

Chlorinity = Measure of chloride content, by mass, of water.

$S(0/00) = 1.80655 \times \text{Chlorinity}(0/00)$

Temp °C	Chlorinity : 0 Salinity: 0	5.0 ppt 9.0 ppt	10.0 ppt 18.1 ppt	15.0 ppt 27.1 ppt	20.0 ppt 36.1 ppt	25.0 ppt 45.2 ppt
0.0	14.62	13.73	12.89	12.10	11.36	10.66
1.0	14.22	13.36	12.55	11.78	11.07	10.39
2.0	13.83	13.00	12.22	11.48	10.79	10.14
3.0	13.46	12.66	11.91	11.20	10.53	9.90
4.0	13.11	12.34	11.61	10.92	10.27	9.66
5.0	12.77	12.02	11.32	10.66	10.03	9.44
6.0	12.45	11.73	11.05	10.40	9.80	9.23
7.0	12.14	11.44	10.78	10.16	9.58	9.02
8.0	11.84	11.17	10.53	9.93	9.36	8.83
9.0	11.56	10.91	10.29	9.71	9.16	8.64
10.0	11.29	10.66	10.06	9.49	8.96	8.45
11.0	11.03	10.42	9.84	9.29	8.77	8.28
12.0	10.78	10.18	9.62	9.09	8.59	8.11
13.0	10.54	9.96	9.42	8.90	8.41	7.95
14.0	10.31	9.75	9.22	8.72	8.24	7.79
15.0	10.08	9.54	9.03	8.54	8.08	7.64
16.0	9.87	9.34	8.84	8.37	7.92	7.50
17.0	9.67	9.15	8.67	8.21	7.77	7.36
18.0	9.47	8.97	8.50	8.05	7.62	7.22
19.0	9.28	8.79	8.33	7.90	7.48	7.09
20.0	9.09	8.62	8.17	7.75	7.35	6.96
21.0	8.92	8.46	8.02	7.61	7.21	6.84
22.0	8.74	8.30	7.87	7.47	7.09	6.72
23.0	8.58	8.14	7.73	7.34	6.96	6.61
24.0	8.42	7.99	7.59	7.21	6.84	6.50
25.0	8.26	7.85	7.46	7.08	6.72	6.39

Temp °C	Chlorinity : 0 Salinity: 0	5.0 ppt 9.0 ppt	10.0 ppt 18.1 ppt	15.0 ppt 27.1 ppt	20.0 ppt 36.1 ppt	25.0 ppt 45.2 ppt
26.0	8.11	7.71	7.33	6.96	6.62	6.28
27.0	7.97	7.58	7.20	6.85	6.51	6.18
28.0	7.83	7.44	7.08	6.73	6.40	6.09
29.0	7.69	7.32	6.93	6.62	6.30	5.99
30.0	7.56	7.19	6.85	6.51	6.20	5.90
31.0	7.43	7.07	6.73	6.41	6.10	5.81
32.0	7.31	6.96	6.62	6.31	6.01	5.72
33.0	7.18	6.84	6.52	6.21	5.91	5.63
34.0	7.07	6.73	6.42	6.11	5.82	5.55
35.0	6.95	6.62	6.31	6.02	5.73	5.46
36.0	6.84	6.52	6.22	5.93	5.65	5.38
37.0	6.73	6.42	6.12	5.84	5.56	5.31
38.0	6.62	6.32	6.03	5.75	5.48	5.23
39.0	6.52	6.22	5.98	5.66	5.40	5.15
40.0	6.41	6.12	5.84	5.58	5.32	5.08
41.0	6.31	6.03	5.75	5.49	5.24	5.01
42.0	6.21	5.93	5.67	5.41	5.17	4.93
43.0	6.12	5.84	5.58	5.33	5.09	4.86
44.0	6.02	5.75	5.50	5.25	5.02	4.79
45.0	5.93	5.67	5.41	5.17	4.94	4.72

Item # 605056
Rev C
Drawing # A605056
November 2010

©2010 YSI Incorporated.